

GROOVE 'N TURN® INSERTS

U.S. PATENT NOS. 6,688,816 and 6,824,333

PRODUCT INFORMATION

- Face grooving for major diameters .300", .750", 1.250", 3" and greater.
- Face grooving with a central hub, recessed or flat face.
- .004" - .150" in .001" increments available.
- Sub-micron grain **DURA-MAX® 2000** and **5000** Carbides.
- Inserts available with TiN, TiAlN, TiCN and Diamond coating.



MODIFICATIONS

SEE PAGES 8-2 & 8-3 FOR ADDITIONAL INFORMATION

RADII (TOP VIEW)	DEPTH OF CUT (TOP VIEW)	SIZING (TOP VIEW)	BACK CLEARANCE (TOP VIEW)
LEAD ANGLE (TOP VIEW)	TOP RAKE (SIDE VIEW)	CHIP BREAKER (SIDE VIEW)	SIDE CLEARANCE (END VIEW)

TOOLHOLDER SELECTIONS

CNC, SWISS, CONVENTIONAL STYLE

ROUND STYLE

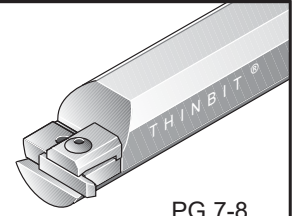
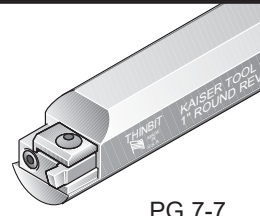
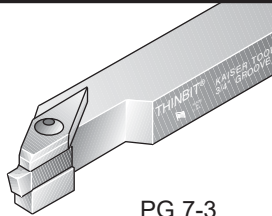

45° STYLE

SWISS FACE STYLE



TECHNICAL SECTIONS

PRODUCT DEMONSTRATION



www.thinbit.com/qr2-9

SPEEDS AND FEEDS

PG 9-12

APPLICATION REFERENCE

PGS 9-3 & 9-4

TROUBLESHOOTING

PG 9-7

KAISER TOOL COMPANY, INC.

Phone: 888-THINBIT (888-844-6248) or (260) 484-3620 • Fax: 888-THINFAX (888-844-6329) or (260) 482-1881
www.thinbit.com • General E-mail: thinbit@kaisertool.com • Orders: orders@thinbit.com • Quotes: quotes@thinbit.com

FACE GROOVING INSERTS

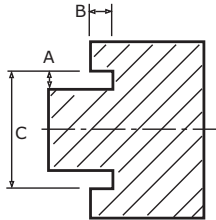
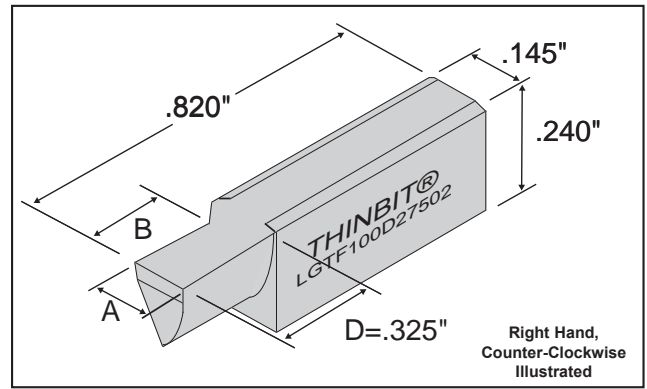
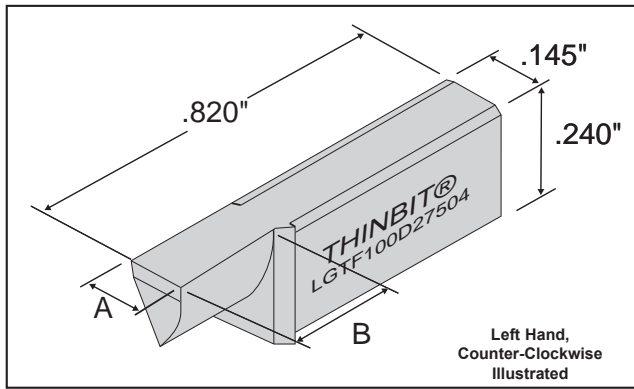

FRONT RAKE: Primary 10° honed, Secondary 15°
 BACK CLEARANCE: 2-1/2° both sides
 SIDE CLEARANCE: .004" - .019" - 0° ID side
 .020" - .150" - 5° ID side
 RADIUS: Sharp corner through full radius available
 TOP RAKE: 0°
 LEAD ANGLE: 0°

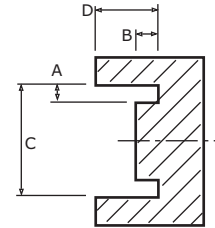

Cut with a LH CCW Insert

NOTE: Capable of grooving along a shoulder

Cut with a RH CCW Insert

ORDERING INSTRUCTIONS

EXAMPLE:

Sample **ORDER CODE** for a left hand/counter-clockwise, .100" wide insert in **DURA-MAX® 2000**, with a .750" major diameter and no corner radius is:

LGTF 100 D27504

Specify the Insert Width 'A'

SPECIFICATIONS				ORDER CODE			INFO.		
Insert Orientation	Insert Width	Depth of Cut	Major Diameter	Insert Grades <small>See Page 9-5 for expanded material descriptions and Page 9-12 for Speeds and Feeds information</small>		Add-ons <small>Use 'Order Code' and Add</small>		Toolholder Catalog Section 7 Use Toolholders Beginning With 'L'	
	'A' ± .001"	'B'	Can be used on any diameter equal to or greater than listed	DURA-MAX® 2000 Carbide For Steel & Interrupted Cutting	DURA-MAX® 5000 Carbide For Aluminum & Nonferrous	Full Radius Page 8-3	Corner Radius Page 8-3		Coating Page 9-6
Left Hand/ Counter-Clockwise	.004" - .150"	Width D.O.C. .004"-.033" = 3 x 'A' .034"-.039" = .100" .040"-.100" = 2.5 x 'A' .101"-.150" = .250"	.300"	LGTF ___ D23004	LGTF ___ D53004	add 'FR'	(indicate size in .xxx")	TiN add 'C' TiCN add 'D' TiAIN add 'E' Diamond add 'F'	For shoulder cutting use left hand straight holder or right hand 90° holder Use right hand or left hand straight holder or right hand 90° holder
			.750"	LGTF ___ D27504	LGTF ___ D57504				
			1.250"	LGTF ___ D212504	LGTF ___ D512504				
			* 3.000"	LGT ___ D2L	LGT ___ D5L				
Right Hand/ Counter-Clockwise	.004" - .150"	Width D.O.C. .004"-.033" = 3 x 'A' .034"-.039" = .100" .040"-.100" = 2.5 x 'A' .101"-.150" = .250"	.300"	LGTF ___ D23002	LGTF ___ D53002	add 'FR'	(indicate size in .xxx")	TiN add 'C' TiCN add 'D' TiAIN add 'E' Diamond add 'F'	For shoulder cutting use left hand straight holder or right hand 90° holder Use right hand or left hand straight holder or right hand 90° holder
			.750"	LGTF ___ D27502	LGTF ___ D57502				
			1.250"	LGTF ___ D212502	LGTF ___ D512502				
			* 3.000"	LGT ___ D2R	LGT ___ D5R				

* 3.000" Major Diameter Excludes .004" - .019" Insert Width Due to Side Clearance

KAISER TOOL COMPANY, INC.

Phone: 888-THINBIT (888-844-6248) or (260) 484-3620 • Fax: 888-THINFAX (888-844-6329) or (260) 482-1881
 www.thinbit.com • General E-mail: thinbit@kaisertool.com • Orders: orders@thinbit.com • Quotes: quotes@thinbit.com

INSERTS
FACE GROOVING

PRODUCT INFORMATION

- Designed for CNC, conventional and top slide position on Swiss screw machines.
- Shank sizes 5/16", 3/8", 1/2", 5/8", 3/4", 1" and 1-1/4". Metric sizes also available.
- Modifications can be provided on any of our tooling. Please contact us with your application requirements.

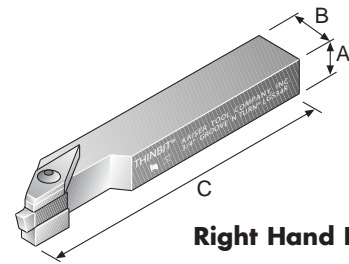

Right Hand Illustrated

INSERT SELECTIONS

GROOVING

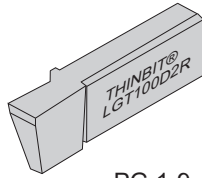

PG 1-9

FACE GROOVING

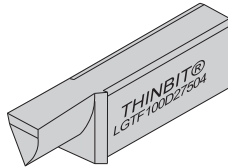

PG 2-9

THREADING

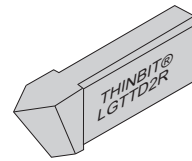

PG 4-9

PARTING

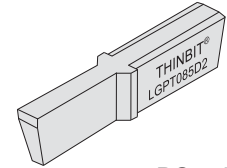

PG 5-3



Scan this code for additional information.

www.thinbit.com/qr7-3

ORDERING INSTRUCTIONS

Select the **ORDER CODE** in the table below that represents your selection of shank dimensions.

EXAMPLE:

The **ORDER CODE** for a .750" Right Hand square shank for inserts beginning with 'L' is:

LGS34R

SPECIFICATIONS				ORDER CODE					
Shank Orientation	Shank Dimensions			Toolholder Package Includes Shank, Clamp and Hardware		Replacement Parts			
	'A'	'B'	'C'	For Inserts Beginning With 'L'		Clamp	Screw	Wrench	Pin
RIGHT HAND	LEFT HAND								
Straight Use right hand holder with right hand inserts Use left hand holder with left hand inserts	.312"	.500"	4.840"	LGS56R	LGS56L	Right Hand: Clamp X Left Hand: Clamp Y	S3808	W1005	P0206
	.375"	.500"	4.840"	LGS38R	LGS38L				
	.500"	.500"	4.840"	LGS12R	LGS12L				
	.625"	.625"	4.840"	LGS58R	LGS58L				
	.750"	.750"	4.840"	LGS34R	LGS34L				
	1.000"	1.000"	4.840"	LGS01R	LGS01L				
	1.250"	1.250"	4.840"	LGS14R	LGS14L				
	8mm	.500"	4.840"	LGS08RM	LGS08LM				
	10mm	.500"	4.840"	LGS10RM	LGS10LM				
	12mm	.500"	4.840"	LGS12RM	LGS12LM				
	16mm	.750"	4.840"	LGS16RM	LGS16LM				
	20mm	1.000"	4.840"	LGS20RM	LGS20LM				
25mm	1.000"	4.840"	LGS25RM	LGS25LM					

KAISER TOOL COMPANY, INC.

PRODUCT INFORMATION

- Designed for CNC and conventional machines.
- Shank sizes 5/16", 3/8", 1/2", 5/8", 3/4", 1" and 1-1/4". Metric sizes also available.
- Modifications can be provided on any of our tooling. Please contact us with your application requirements.

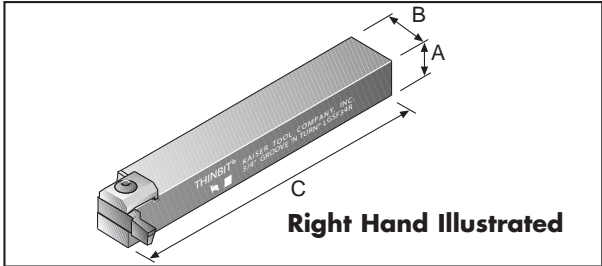

INSERT SELECTIONS

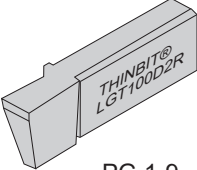
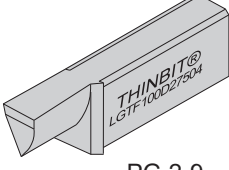
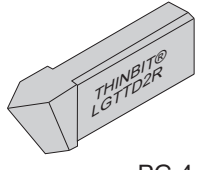
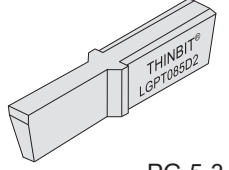
GROOVING	FACE GROOVING	THREADING	PARTING
 PG 1-9	 PG 2-9	 PG 4-9	 PG 5-3



Scan this code for additional information.

www.thinbit.com/qr7-4

ORDERING INSTRUCTIONS

Select the **ORDER CODE** in the table below that represents your selection of shank orientation and dimensions.

EXAMPLE:

The **ORDER CODE** for a .750" right hand shank for inserts beginning with 'L' is:
LGSF34R

SPECIFICATIONS				ORDER CODE					
Shank Orientation	Shank Dimensions			Toolholder Package <small>Includes Shank, Clamp and Hardware For Inserts Beginning With 'L'</small>		Replacement Parts			
	'A'	'B'	'C'	RIGHT HAND	LEFT HAND	Clamp	Screw	Wrench	Pin
90° Use right hand holder with left hand inserts	.312"	.500"	4.840"	LGSF56R		Clamp C	S3808	W1005	P0312
	.375"	.500"	4.840"	LGSF38R					
	.500"	.500"	4.840"	LGSF12R					
	.625"	.625"	4.840"	LGSF58R	LGSF58L				
	.750"	.750"	4.840"	LGSF34R	LGSF34L				
	1.000"	1.000"	4.840"	LGSF01R	LGSF01L				
	1.250"	1.250"	4.840"	LGSF14R	LGSF14L				
Use left hand holder with right hand inserts	8mm	.500"	4.840"	LGSF08RM					
	10mm	.500"	4.840"	LGSF10RM					
	12mm	.500"	4.840"	LGSF12RM					
	16mm	.750"	4.840"	LGSF16RM	LGSF16LM				
	20mm	1.000"	4.840"	LGSF20RM	LGSF20LM				
	25mm	1.000"	4.840"	LGSF25RM	LGSF25LM				

GROOVE 'N TURN®
TOOLHOLDERS

KAISER TOOL COMPANY, INC.

Phone: 888-THINBIT (888-844-6248) or (260) 484-3620 • Fax: 888-THINFAX (888-844-6329) or (260) 482-1881
www.thinbit.com • General E-mail: thinbit@kaisertool.com • Orders: orders@thinbit.com • Quotes: quotes@thinbit.com

PRODUCT INFORMATION

- Designed for top slide position on Swiss screw machines.
- Shank sizes 1/2", 12mm and 16mm in right hand orientation.
- Modifications can be provided on any of our tooling. Please contact us with your application requirements.

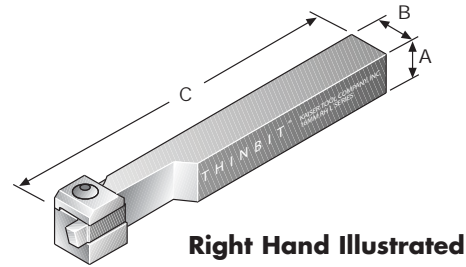

INSERT SELECTIONS

GROOVING

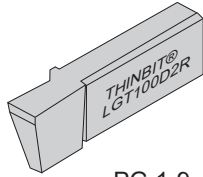

PG 1-9

THREADING

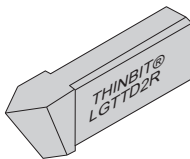

PG 4-9

PARTING

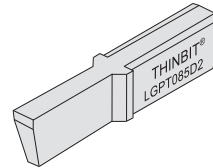

PG 5-3



Scan this code for additional information.

www.thinbit.com/qr7-5

ORDERING INSTRUCTIONS

Select the **ORDER CODE** in the table below that represents your selection of shank orientation and dimensions.

EXAMPLE:

The **ORDER CODE** for a .500" shank, right hand tool for inserts beginning with 'L' is:
LSS12R

SPECIFICATIONS				ORDER CODE				
Shank Orientation	Shank Dimensions			Toolholder Package Includes Shank, Clamp and Hardware For Inserts Beginning With 'L'	Replacement Parts			
	'A'	'B'	'C'		Clamp	Screw	Wrench	Pin
Right Hand	.500"	.500"	4.840"	LSS12R	Clamp C	S3808	W1005	P0305
Use with right hand and centered inserts	12mm	12mm		LSS12RM				
	16mm	16mm		LSS16RM				
Left Hand	.500"	.500"	4.840"	LSS12L				
Use with left hand and centered inserts	12mm	12mm		LSS12LM				
	16mm	16mm		LSS16LM				

KAISER TOOL COMPANY, INC.

PRODUCT INFORMATION

- Designed for top slide position on Swiss screw machines.
- Shank sizes 3/8", 1/2", 10mm, 12mm and 16mm in right hand orientation.
- Modifications can be provided on any of our tooling. Please contact us with your application requirements.

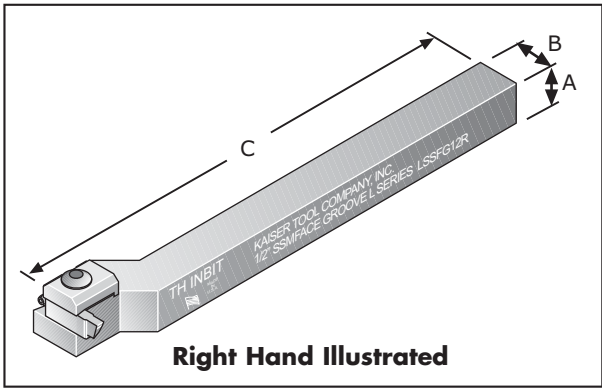

INSERT SELECTIONS

FACE GROOVING

PG 2-9



Scan this code for additional information.

www.thinbit.com/qr7-6

ORDERING INSTRUCTIONS

Select the **ORDER CODE** in the table below that represents your selection of shank orientation and dimensions.

EXAMPLE:

The **ORDER CODE** for a .375" Right Hand shank for inserts beginning with 'L' is:

LSSFG38R

SPECIFICATIONS				ORDER CODE				
Shank Orientation	Shank Dimensions			Toolholder Package Includes Shank, Clamp and Hardware For Inserts Beginning With 'L'	Replacement Parts			
	'A'	'B'	'C'		Clamp	Screw	Wrench	Pin
Right Hand Use with left hand and centered inserts for counter-clockwise rotation	.375"	.375"	4.840"	LSSFG38R	Clamp C	S3808	W1005	P0203
	.500"	.500"	4.840"	LSSFG12R				
	10mm	10mm	4.840"	LSSFG10RM				
	12mm	12mm	4.840"	LSSFG12RM				
	16mm	16mm	4.840"	LSSFG16RM				

SWISS
TOOLHOLDERS

KAISER TOOL COMPANY, INC.

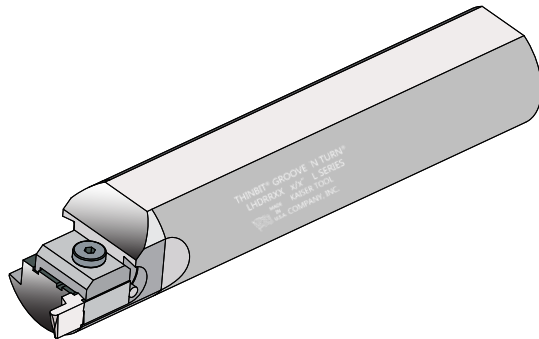
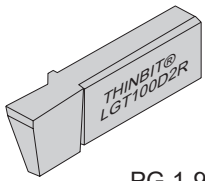
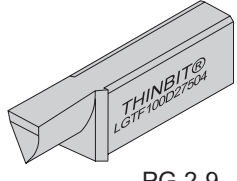
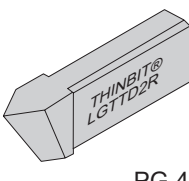
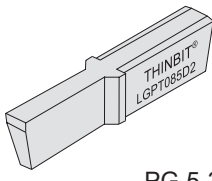
PRODUCT INFORMATION	<ul style="list-style-type: none"> Designed for boring bar positions on all machines. Can be used with a boring head to trepan on a mill. Shank may need to be shortened. Toolholder reversible by changing clamp to other side. Shank sizes 12mm, 1/2", 5/8", 16mm, 3/4" 20mm, 22mm, 25mm and 1". All 1/2", 5/8" and 3/4" shanks are made from 1" shank. For a shortened shank see page 11-2. Modifications can be provided on any of our tooling. Please contact us with your application requirements. 				 <p>Heavy Duty Round Reversible Toolholder</p>							
	INSERT SELECTIONS	GROOVING	FACE GROOVING	THREADING	PARTING	 <p>PG 1-9</p>		 <p>PG 2-9</p>		 <p>PG 4-9</p>		 <p>PG 5-3</p>

ORDERING INSTRUCTIONS

Select the **ORDER CODE** in the table below that represents your selection of shank dimensions.

EXAMPLE:

The **ORDER CODE** for a 3/4" round shank for inserts beginning with 'L' is:

LHDRR34

SPECIFICATIONS		ORDER CODE		
Shank Orientation	Shank Dimensions	Toolholder Package Includes Shank, Clamp and Hardware		
	'A'	For Inserts Beginning With	Clamp	Clamp Hardware
		'L'		
<p style="text-align: center;">Right Hand or Left Hand</p> <p>Use as right hand with right hand inserts</p> <p>Use as left hand with left hand inserts</p> <p>Use as either hand with centered inserts</p>	1/2"	LHDRR12	Clamp C	Screw: S3808 Wrench: W1005 Pin: P0305
	5/8"	LHDRR58		
	3/4"	LHDRR34		
	1"	LHDRR01		
	12 mm	LHDRR12M		
	16 mm	LHDRR16M		
	20 mm	LHDRR20M		
	22 mm	LHDRR22M		
25 mm	LHDRR25M			

KAISER TOOL COMPANY, INC.

PRODUCT INFORMATION

- Designed for boring bar positions on all machines.
- Toolholder reversible for left and right hand orientation.
- Shank sizes 1/2", 5/8", 3/4" and 1".
- All 1/2", 5/8" and 3/4" shanks are made from 1" shank.
- Modifications can be provided on any of our tooling. Please contact us with your application requirements.

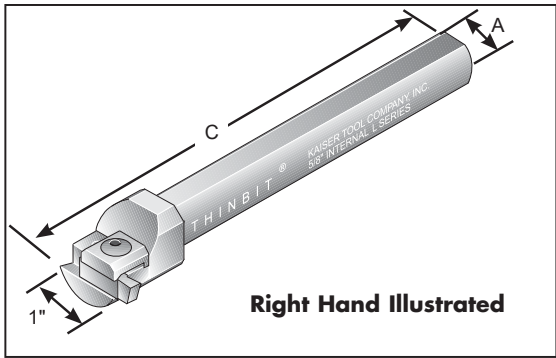

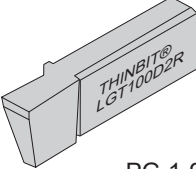
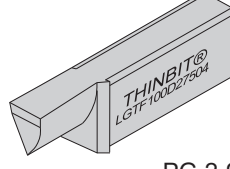
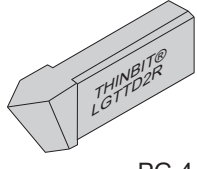
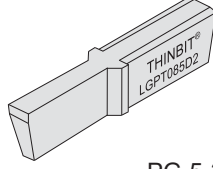
INSERT SELECTIONS	GROOVING	FACE GROOVING	THREADING	PARTING
	 PG 1-9	 PG 2-9	 PG 4-9	 PG 5-3



Scan this code for additional information.

www.thinbit.com/qr7-8

ORDERING INSTRUCTIONS

Select the **ORDER CODE** in the table below that represents your selection of shank orientation and dimensions.

EXAMPLE:

The **ORDER CODE** for a .625" right hand shank for inserts beginning with 'L' is:

LR5806

SPECIFICATIONS				ORDER CODE				
Shank Orientation	Minimum Bore Diameter	Shank Dimensions		Toolholder Package Includes Shank, Clamp and Hardware	Replacement Parts			
		'A'	'C'		For Inserts Beginning With 'L'			
	without pin				Clamp	Screw	Wrench	Pin
Right Hand or Left Hand Use as right hand with left hand inserts; Use as left hand with right hand inserts; Use as either hand with centered inserts.	1.250"	.500"	5.500"	LR1206	Clamp C	S3808	W1005	P0305
		.625"		LR5806				
		.750"		LR3406				
		1.000"	5.500"	LR0106				
			11.875"	LR0112				

ROUND TOOLHOLDERS

KAISER TOOL COMPANY, INC.

PRODUCT INFORMATION

- Designed for making angled undercuts.
- Toolholder must be used with inserts that have radial relief.
- Groove widths less than .080" may require a special insert.
- Shank sizes 3/8", 1/2", 5/8", 3/4" and 1".
- Modifications can be provided on any of our tooling. Please contact us with your application requirements.

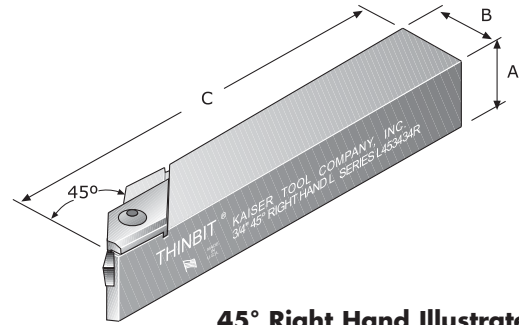

45° Right Hand Illustrated

INSERT SELECTIONS

FACE GROOVING

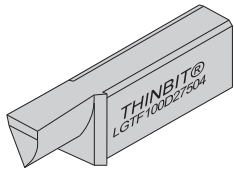

PG 2-9

Due to the potential complexity of configuring these toolholders, we recommend calling for assistance.



Scan this code for additional information

www.thinbit.com/qr7-11

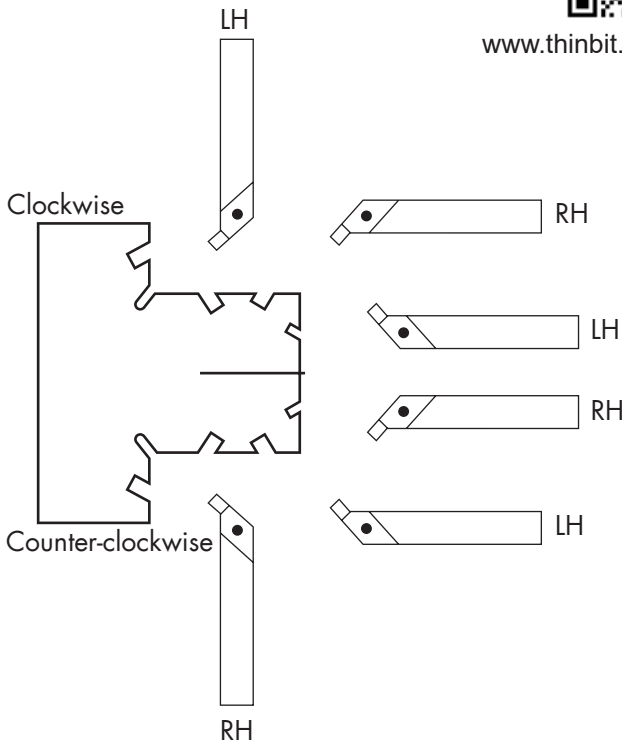

APPLICATION EXAMPLES
 TOP VIEW, CUTTING EDGE UP

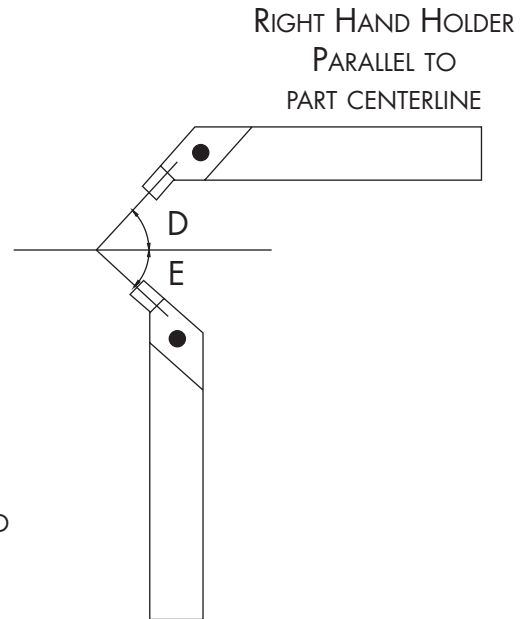

45° ILLUSTRATED

RIGHT HAND HOLDER
 PERPENDICULAR TO
 PART CENTERLINE

KAISER TOOL COMPANY, INC.

ORDERING INSTRUCTIONS

Select the **ORDER CODE** in the table below that represents your selection of shank orientation and dimensions.

EXAMPLE:

The **ORDER CODE** for a 45° holder with a .750" right hand shank is:

L453434R

SPECIFICATIONS (Page 7-11)						ORDER CODE				
Shank Angle		Shank Orientation	Shank Dimensions			Toolholder Package Includes Shank, Clamp and Hardware For Inserts Beginning With 'L'	Replacement Parts			
'D' <small>Toolholder parallel to part centerline</small>	'E' <small>Toolholder perpendicular to part centerline</small>		'A'	'B'	'C'		Clamp	Screw	Wrench	Pin
45°	45°	Right Hand Use with left hand and centered inserts for counter-clockwise rotation	.375"	.750"	4.840"	L453438R	Clamp Q	S3808	W1005	* C0509
			.500"			L453412R				
			.625"			L453458R				
			.750"			L453434R				
			1.000"			L450101R				
		Left Hand Use with right hand and centered inserts for clockwise rotation	.375"	.750"	4.840"	L453438L	Clamp R			
			.500"			L453412L				
			.625"			L453458L				
			.750"			L453434L				
			1.000"			L450101L				
60°	30°	Right Hand Use with left hand and centered inserts for counter-clockwise rotation	.375"	.750"	4.840"	L363438R	Clamp Y			
			.500"			L363412R				
			.625"			L363458R				
			.750"			L363434R				
			1.000"			L360101R				
		Left Hand Use with right hand and centered inserts for clockwise rotation	.375"	.750"	4.840"	L363438L	Clamp X			
			.500"			L363412L				
			.625"			L363458L				
			.750"			L363434L				
			1.000"			L360101L				

45° & 30°/60° TOOLHOLDERS

* Roll Pin sizes may have changed due to manufacturing updates. Toolholders will be shipped with the correct item. Replacement pin (C0509) will contain two items (P0204 & P0305) to accommodate either revision.

KAISER TOOL COMPANY, INC.